

▼ Shown: EPHR-110



- Patented 'Safety Cage' jaw retention system
- High force hydraulic system for effortless pulling of large components
- Slim tapered jaws for better gripping in tight spots
- Available in 2 and 3 jaw design
- More efficient pulling, as one man can do the job where manual pullers often require two operators.



◀ An EPHR-116, 50 ton hydraulic Posi Lock® puller easily removes the main drive gear from this metal forming brake press.

## High-Tech Pulling



### Transport and Store

Conveniently stores and transports hydraulic pullers and accessories.

Order the **EPT-2550** Storage Cart and make your job easier to do!



### Long Jaws

Used to increase the reach and spread of pullers. They maintain the same pulling capacity as the standard jaws, but reduce clamping force to 25%.

Page: 166



### Application Tip

Because of the unique safety cage design, Posi Lock® pullers will grip on surfaces where normal pullers would slip off; e.g. tapered bearings.



Visit the **Products** section of our web site for more information and product selection charts regarding puller sets and individual puller component parts.

[www.enerpac.com](http://www.enerpac.com)

Number of Jaws	Maximum Spread	Capacity	Model Number*
	(mm)	ton (kN)	
2	304	10 (101)	EPH-208
3	304		EPH-108
2	381	15 (142)	EPH-210
3	381		EPH-110
2	457	25 (232)	EPH-213
3	457		EPH-113
2	635	50 (498)	EPH-216
3	635		EPH-116

\* Cylinder is not included.

# Posi Lock® Hydraulic Grip Pullers

## ▼ SETS SELECTION CHART

Style	Capacity (ton)	Basic Puller	Cylinder	Stroke (mm)	Pump Set	Set Model Number*	 (kg)
2 Jaw Puller	10	EPH-208	RC-106	152	-	EPHR208	10
	10	EPH-208	RC-106	152	EP-1E	EPHS208E	27
	15	EPH-210	RC-1510	254	-	EPHR210	22
	15	EPH-210	RC-1510	254	EP-1E	EPHS210E	38
	25	EPH-213	RC-2514	362	-	EPHR213	44
	25	EPH-213	RC-2514	362	EP-1E	EPHS213E	53
	50	EPH-216	RC-5013	336	-	EPHR216	87
	50	EPH-216	RC-5013	336	EP-2E	EPHS216E	123
3 Jaw Puller	10	EPH-108	RC-106	152	-	EPHR108	11
	10	EPH-108	RC-106	152	EP-1E	EPHS108E	28
	15	EPH-110	RC-1510	254	-	EPHR110	23
	15	EPH-110	RC-1510	254	EP-1E	EPHS110E	39
	25	EPH-113	RC-2514	362	-	EPHR113	48
	25	EPH-113	RC-2514	362	EP-1E	EPHS113E	57
	50	EPH-116	RC-5013	336	-	EPHR116	91
	50	EPH-116	RC-5013	336	EP-2E	EPHS116E	127

\* Standard set EPHS models shipped with 230 VAC pump.

## EPH Series



Capacity:

**10-50 ton**

Maximum Reach:

**203-355 mm**

Spread Range:

**19-635 mm**

Maximum Operating Pressure:

**700 bar**



### Pump Sets



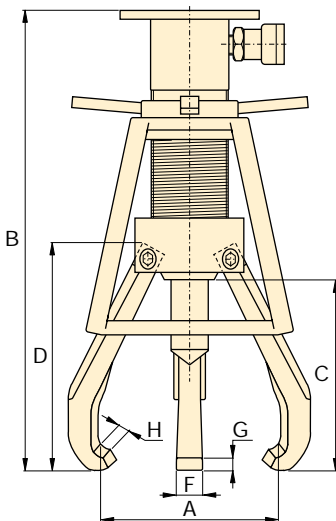

All Posi Lock Hydraulic Puller Sets that include 230 VAC pumps, will feature the following components:

	EP-1E Pump Set	EP-2E Pump Set
Pump	PUJ-1200E	ZE4210ME
Hose	HC-7210	HC-7210
Gauge	G-2535L	G-2535L
Adaptor	-	GA-3

Components for 115 VAC pumps are available on request.





### Dimensions (mm)

Dimensions (mm)							 (kg)	Model Number*	Accessories <sup>1)</sup>		
Spread min. - max.	Overall Length	Maximum Reach	Jaw Length	Jaw Width	Tip Clearance	Tip Depth					
A	B	C	D	F	G	H			Ram Point Sets	Lift Plates	Long Jaws
19 - 304	498	203	237	22	7,4	6,9	6,4	<b>EPH-208</b>	EPH-155	EPH-11052	EPH-11054
19 - 304	498	203	237	22	7,4	6,9	7,3	<b>EPH-108</b>	EPH-155	EPH-11052	EPH-11054
25 - 381	665	245	270	25	11,2	9,1	10,0	<b>EPH-210</b>	EPH-155	EPH-11052	EPH-11054L
25 - 381	665	245	270	25	11,2	9,1	11,3	<b>EPH-110</b>	EPH-155	EPH-11052	EPH-11054L
63 - 457	846	304	348	31	12,9	9,7	21,3	<b>EPH-213</b>	EPH-257	EPH-11352	EPH-11354L
63 - 457	846	304	348	31	12,9	9,7	25,0	<b>EPH-113</b>	EPH-257	EPH-11352	EPH-11354L
76 - 635	919	355	413	36	15,0	11,7	40,8	<b>EPH-216</b>	EPH-508	EPH-11652	EPH-21654L
76 - 635	919	355	413	36	15,0	11,7	45,4	<b>EPH-116</b>	EPH-508	EPH-11652	EPH-11654L

<sup>1)</sup> See next page for details.

## ▼ RAM POINT SETS SELECTION CHART

Fits Puller Set Model Number	EPH-208, EPH-210 EPH-108, EPH-110	EPH-213 EPH-113	EPH-216 EPH-116
			
Ram Point Set <sup>1)</sup> Model Number	EPH-155	EPH-257	EPH-508
Ram Points Included:	Ram Point Dimensions Diameter x Length (mm)		
Flat Ram Points	ø25 x 25	ø38 x 57	ø51 x 76
	ø25 x 76	ø51 x 57	ø70 x 76
	–	ø51 x 102	ø70 x 127
Tapered Ram Points	ø25 x 38	ø38 x 64	ø51 x 95
	ø25 x 89	ø51 x 64	ø51 x 95
	–	ø51 x 114	ø70 x 140
Ram Point Adaptor	–	–	ø70 x 57

<sup>1)</sup> Standard included in EPH-Series Posi Lock Pullers.



Always wear Safety Goggles while using pullers.



Visit the **Products** section of our web site for more information and product selection charts regarding puller sets and individual puller component parts.  
[www.enerpac.com](http://www.enerpac.com)



## ▼ LIFT PLATE SELECTION CHART

Fits Puller Set Model Number	Model Number *	Thickness (mm)	Diameter (mm)
EPH-208	EPH-11052	6,4	ø153
EPH-108	EPH-11052	6,4	ø153
EPH-210	EPH-11052	6,4	ø153
EPH-110	EPH-11052	6,4	ø153
EPH-213	EPH-11352	9,7	ø203
EPH-113	EPH-11352	9,7	ø203
EPH-216	EPH-11652	9,7	ø254
EPH-116	EPH-11652	9,7	ø254

\* Mounting screws included. Lifting plates are standard included with EPH-Series Pullers.

◀ EPH-116 used to remove electric motor pullies. Puller is positioned using the Lift Plate.

## ▼ LONG JAW SELECTION CHART

Fits Puller Set Model Number	Model Number	Number of Jaws required	Spread (mm)	Reach (mm)	Weight (kg)
EPH-208	EPH-11054	2	57 - 381	246	1,1
EPH-108	EPH-11054	3	57 - 381	246	1,1
EPH-210	EPH-11054L	2	38 - 559	401	2,5
EPH-110	EPH-11054L	3	38 - 559	401	2,5
EPH-213	EPH-11354L	2	38 - 762	508	4,8
EPH-113	EPH-11354L	3	38 - 762	508	4,8
EPH-216	EPH-21654L	2	50 - 965	635	7,5
EPH-116	EPH-11654L	3	50 - 965	635	7,5



Long Jaws are optional accessories and used for added reach and spread. They have the same load capacity as standard jaws with 25% of the clamping force.