

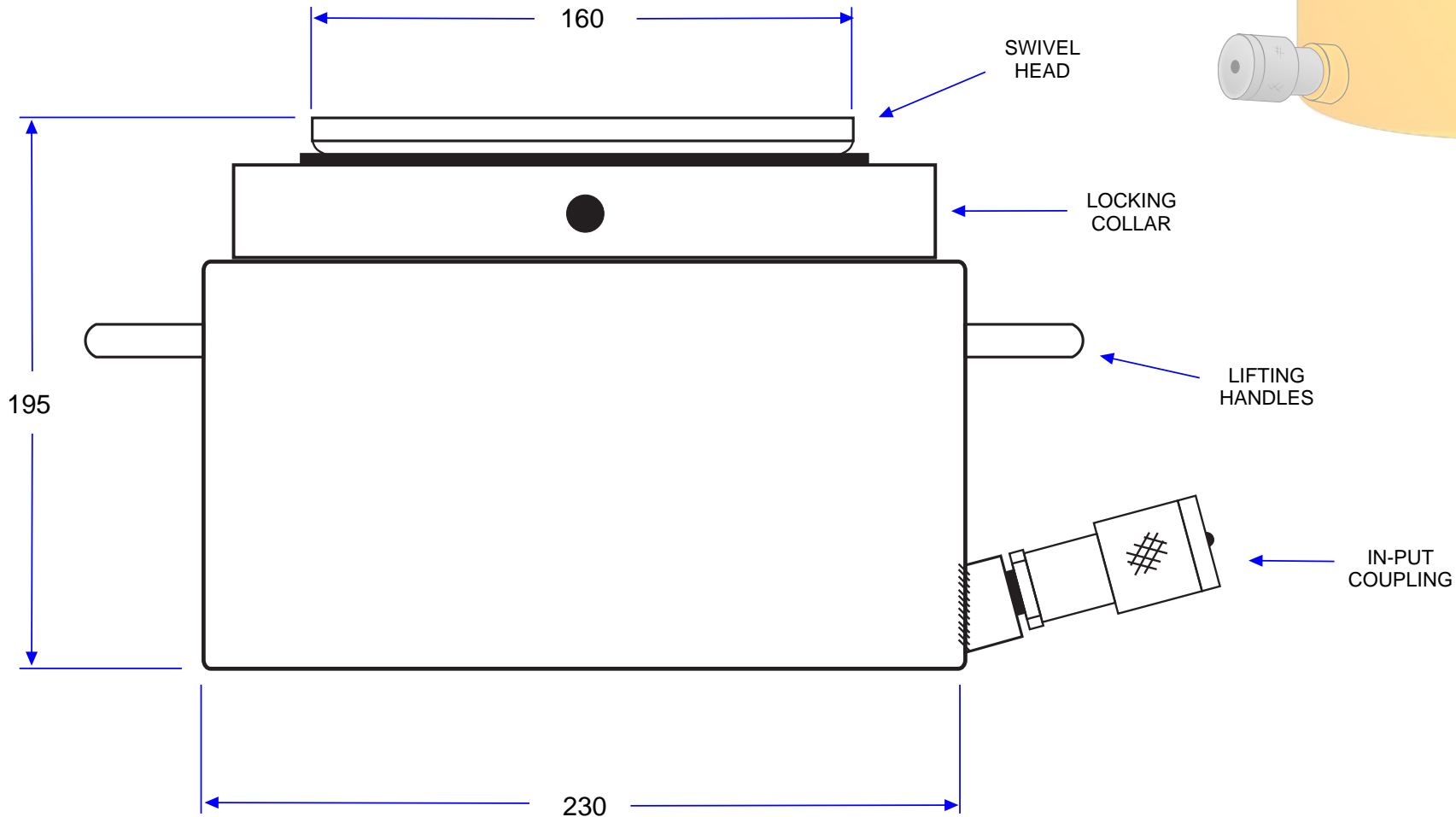

HJ180-40 Hydra-Jack

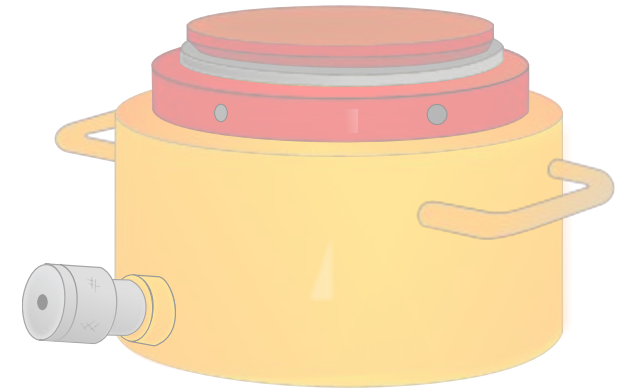

Maximum Capacity	180 tons
Maximum Stroke	40mm
Maximum Pressure	690 bar
Fluid Requirement	1.10 Lts
Jack Weight	53.5 Kgs

 HYDRA-CAPSULE	
HEAVY DUTY JACKING SYSTEMS	
DESCRIPTION:	HJ180-40 Hydra-Jack
DRAWING No.	Xara/HJ180-40/2007-A