

# HJ90-55 Hydra-Jack

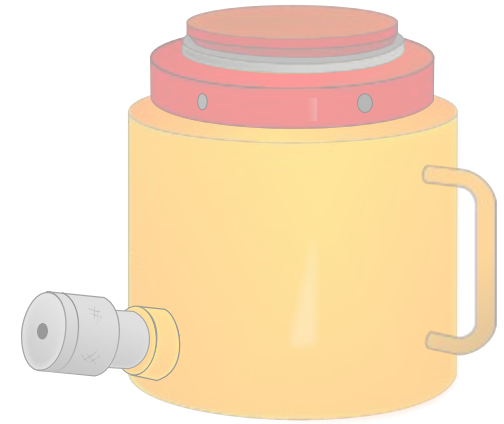
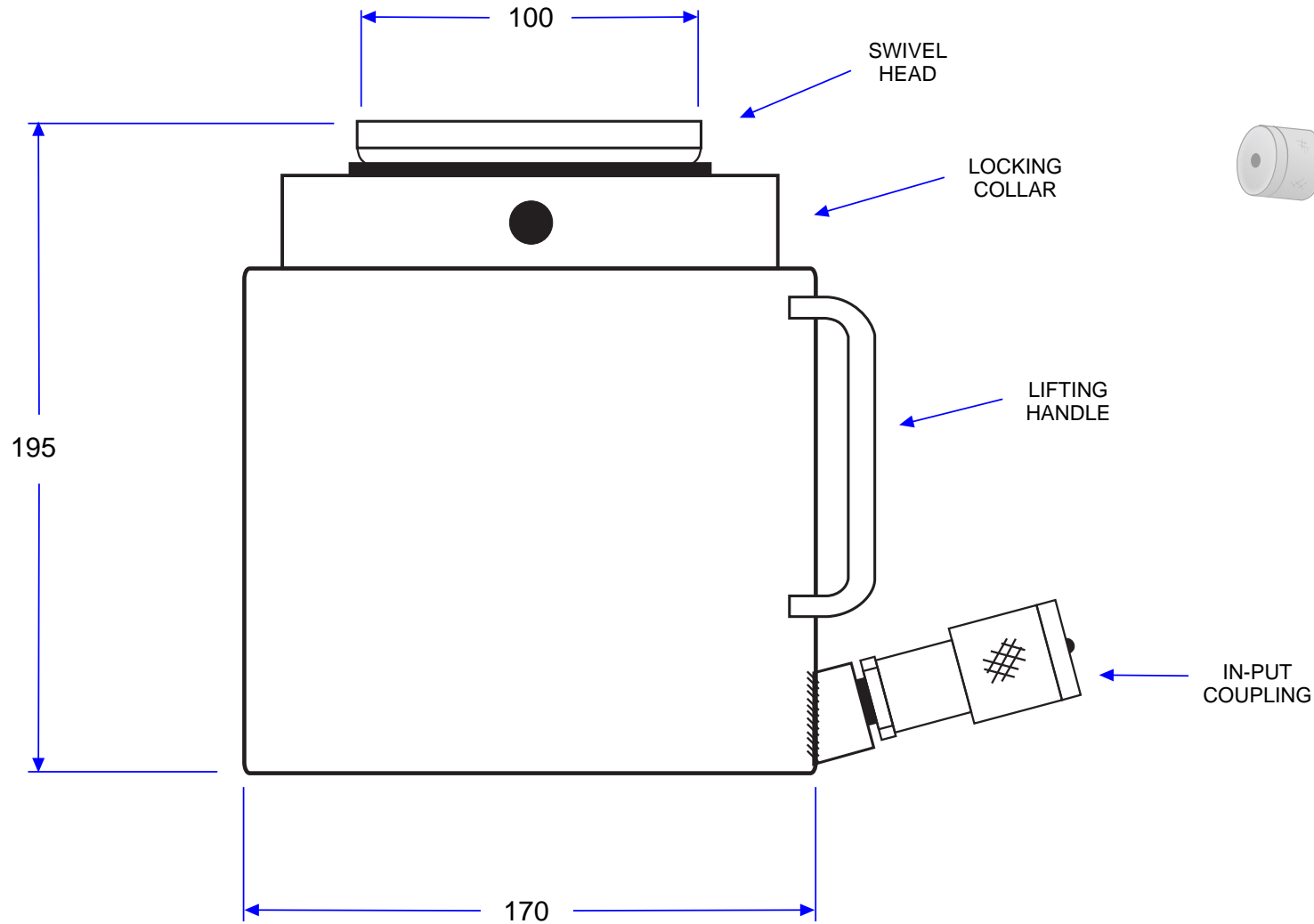

Maximum Capacity	90 tons
Maximum Stroke	55mm
Maximum Pressure	710 bar
Fluid Requirement	0.71 Lts
Jack Weight	28.2 Kgs

<b>HYDRA-CAPSULE</b>	
HEAVY DUTY JACKING SYSTEMS	
DESCRIPTION:	HJ90-55 Hydra-Jack
DRAWING No.	Xara/HJ90-55/2007-A