

PJ45-16 Pad Jacks

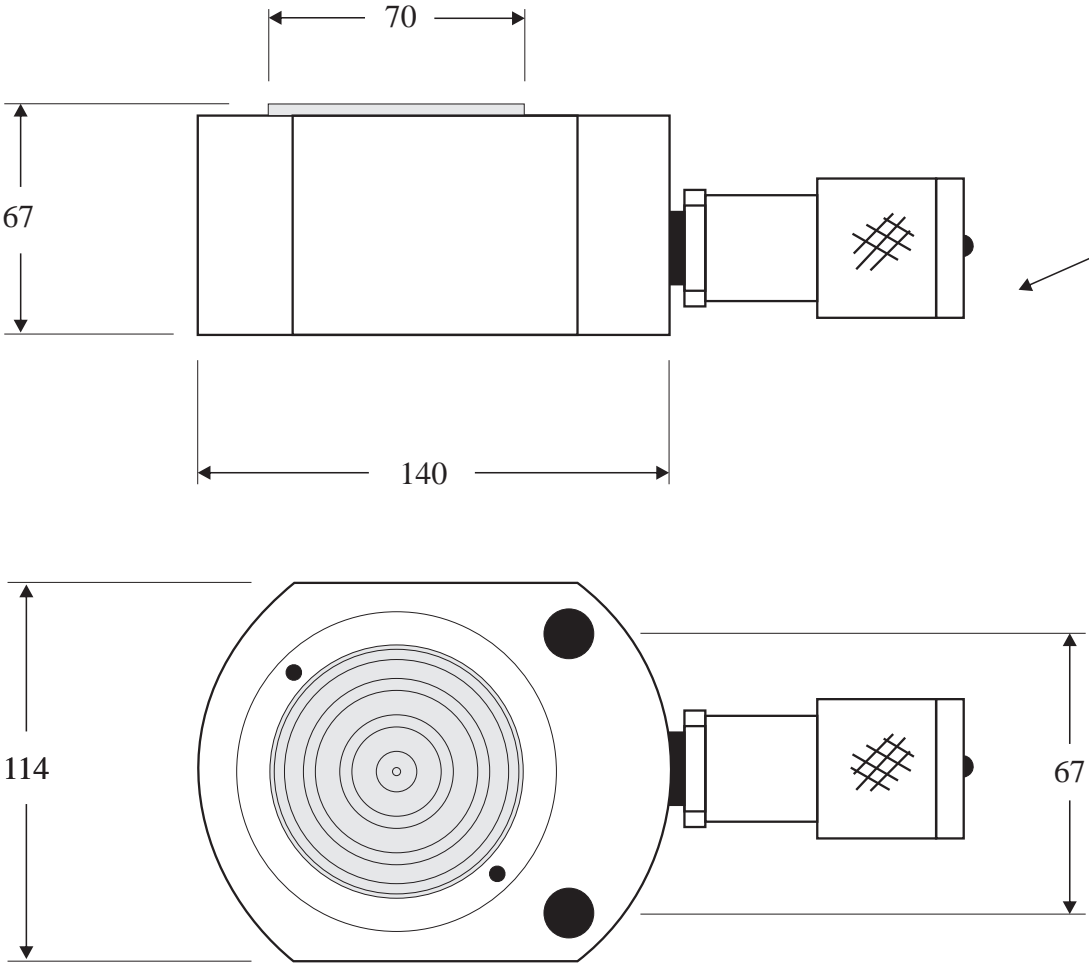

IN-PUT
COUPLING

11mm dia,
Fixing Holes

Maximum Capacity:	450 Kns
Maximum Stroke:	16 mm
Maximum Pressure:	700 Bar
Fluid Requirement:	0.11 Lts
Jack Weight :	6.7 Kgs

HYDRA - CAPSULE	
HEAVY DUTY JACKING SYSTEMS	
DESCRIPTION:	PJ45-16 Pad Jacks
DRAWING No.	CorelDraw-PJ45-16.cdr